



# Bushcomm

## HF Antennas

# Product Catalogue

## 2024

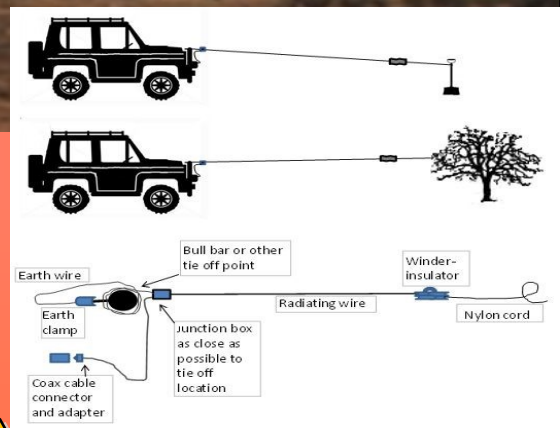

Scan to call. (Australia)



# Broadband

*Made in Australia*



**Bushcomm**  
 2/20 River Road  
 Bayswater. WA  
 Australia 6053

Phone: +61 8 6144 3204  
 Email: [sales@bushcommantennas.com.au](mailto:sales@bushcommantennas.com.au)



## Catalogue Index Links *click on the page title*

A - M	page	M - Z	page
<a href="#">About Bushcomm</a>	24	<a href="#">Marine HF Backstay Antenna</a>	13
<a href="#">Accessories and Cables</a>	20		
<a href="#">Amateur Page</a>	23	<a href="#">Mobile Amateur Whip Antenna</a>	9
<a href="#">Amateur Band Tapped Whip Antenna</a>	9	<a href="#">Mobile HF Tapped Whips</a>	7
<a href="#">Auto Tuners</a>	15	<a href="#">Multi Wire HF Antenna</a>	4
<a href="#">Commercial HF Base Antennas</a>	3	<a href="#">Single Wire HF Antenna</a>	5
<a href="#">Counterpoise products</a>	19	<a href="#">Towers - Light Weight 6,10,12m</a>	17
<a href="#">Emergency Antennas</a>	12	<a href="#">Tower - Portable 5m</a>	18
<a href="#">Folded Dipole</a>	4		
<a href="#">HF Base Station Antenna Amateur</a>	5	<a href="#">Vertical Antenna 7.2m</a>	15
<a href="#">HF Base Antennas Commercial</a>	3		
<a href="#">Horizontal HF Antenna Kits</a>	16		
<a href="#">Masthead Auto Tune Antenna</a>	14		

### Easy links

Click on the page titles above, or use these **easy links buttons** to navigate around the catalogue while viewing it from your computer.



To download more product information



Link to our "Contact us" page



To go between pages



Return to this index page





# BUSHCOMM "BBA" FLAGSHIP SERIES

## COMMERCIAL BROADBAND ANTENNAS

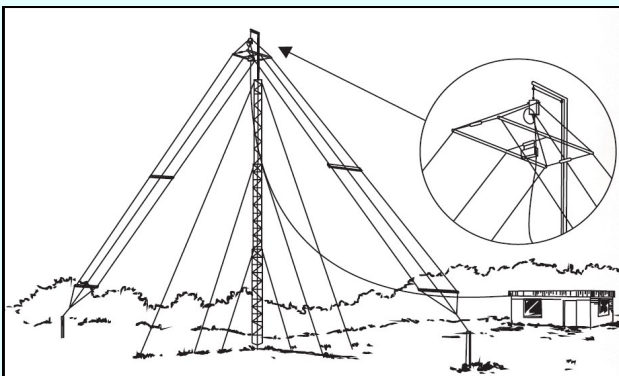

**BBA Series three wire antenna installed in an inverted "V" configuration**

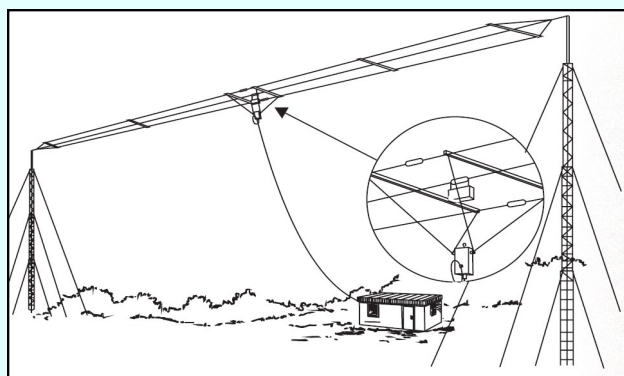

**BBA Series three wire antenna installed in horizontal configuration**

The **Robinson Barnes** three wire HF Broadband Antenna was conceptualised and developed in the early 1990s by Graham Robinson and John Barnes, in South Australia. It has become a widely used design for commercial and military HF base stations where ground space is limited and a full 4 octave bandwidth (2-30 MHz) is required. Graham Robinson was the founder of Bushcomm HF Antennas located in Perth, Western Australia. The "RB" Travelling Wave Antenna is popular for use by the UN, Military, NGOs, and is marketed in various configurations in the BBA Series. *Source: Wikipedia*

[Back a page](#)

[See next page](#)

# BUSHCOMM "BBA" SERIES

## 3-WIRE BROADBAND ANTENNA

Digital & Data modes compatible

MODEL	DESCRIPTION	FREQ	LENGTH		
<a href="#">BBA100V</a>	125W PEP Voice	2.0-30MHZ	27m	<a href="#">More..</a>	<a href="#">BUY NOW</a>
<a href="#">BBA100C</a>	130w (CW)/250w PEP	2.0-30MHZ	27m	<a href="#">More..</a>	<a href="#">BUY NOW</a>
<a href="#">BBA100CS</a>	130w (CW), 250w PEP	3.0-30MHz	20m	<a href="#">More..</a>	<a href="#">BUY NOW</a>
<a href="#">BBA100CE</a>	130w (CW), 250W PEP	1.6-30MHz	54m	<a href="#">More..</a>	<a href="#">BUY NOW</a>
<a href="#">BBA600V</a>	250w (CW), 600w PEP	2.0-30MHz	27m	<a href="#">More..</a>	<a href="#">BUY NOW</a>
<a href="#">BBA600VE</a>	250w (CW), 600w PEP	1.6-30MHz	54m	<a href="#">More..</a>	<a href="#">BUY NOW</a>
<a href="#">BBA1kD</a>	1kW (CW), 2kW PEP	2.0-30MHz	27m	<a href="#">More..</a>	<a href="#">BUY NOW</a>
<a href="#">BBA1kDE</a>	1kW (CW), 2.5kW PEP	1.6-30MHz	54m	<a href="#">More..</a>	<a href="#">BUY NOW</a>

## 2-WIRE FOLDED DIPOLE

**FD-100**      100W Folded Broadband Dipole (2MHz - 30MHz)

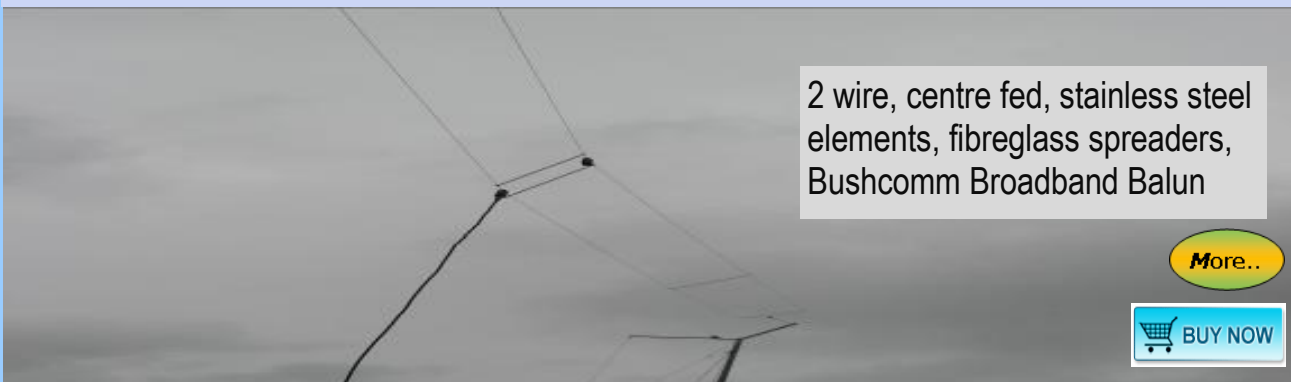

2 wire, centre fed, stainless steel elements, fibreglass spreaders, Bushcomm Broadband Balun

[More..](#)

[BUY NOW](#)

Model	Description	Length
<a href="#">FD-100</a>	100W Folded Dipole (2Mhz-30MHz) (2 wire s/steel)	27m

[Back a page](#)

[See next page](#)

[Back to index](#)



## SINGLE WIRE "SWC-100" ANTENNA

250Watt PEP & Data Rated Models Also Available

Model	Description	Length	
<a href="#"><u>SWC-100</u></a>	Single Wire Centre Fed 125W PEP (2.0MHz-30MHz)	48m	<a href="#">More..</a> <a href="#">BUY NOW</a>
<a href="#"><u>SWC-100CE</u></a>	Single Wire, Centre Fed , 125W PEP (1.8MHz-30MHz)	60m	<a href="#">More..</a> <a href="#">BUY NOW</a>
<a href="#"><u>SWC-100S</u></a>	Single Wire (short), Centre Fed (3.5MHz-30MHz)	34m	<a href="#">More..</a> <a href="#">BUY NOW</a>
<a href="#"><u>SWE 100</u></a>	Single Wire, End Fed (3MHz - 30MHz)	24m	<a href="#">More..</a> <a href="#">BUY NOW</a>
<a href="#"><u>SWE 100P</u></a>	SWE 100 with Quick Deployment Kit	24m	<a href="#">More..</a> <a href="#">BUY NOW</a>
<b>BU00251</b>	<b>Custom 125W PEP single wire centre fed, resonant fixed frequency dipole antenna. Includes a Bushcomm 1:1 balun. High Efficiency</b>	<b>varying</b>	<a href="#">email us here</a> Or phone <b>+61 8 6144 3204</b> <a href="#">Call us here</a>



SWC-100

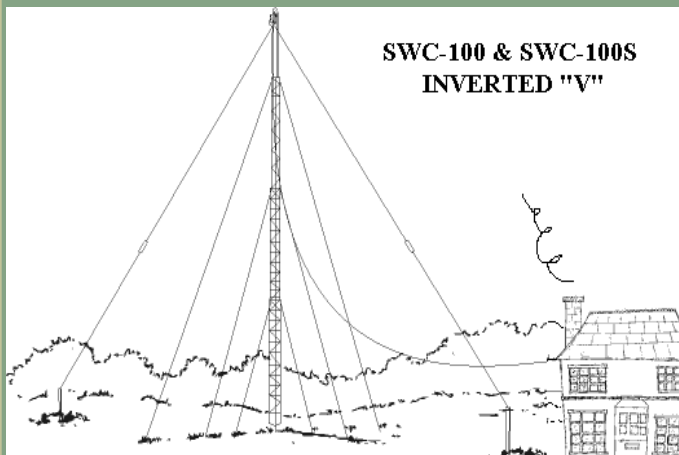

SWC-100 & SWC-100S  
INVERTED "V"

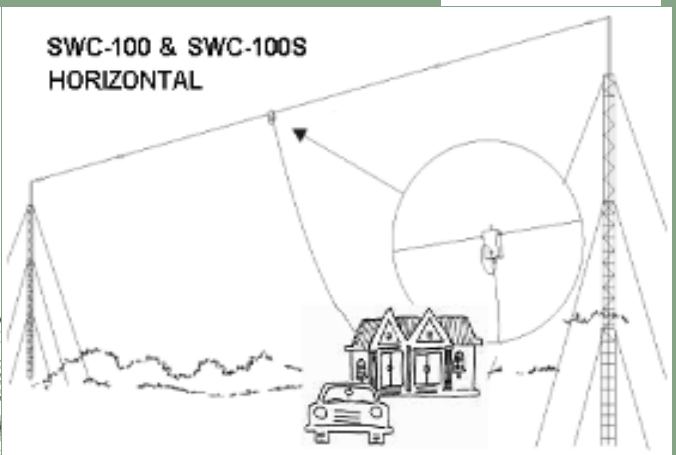

SWC-100 & SWC-100S  
HORIZONTAL

[Back a page](#)

[See next page](#)



**Bushcomm**  
2/20 River Road  
Bayswater. WA  
Australia 6053

[Back to index](#)

Phone: +61 8 6144 3204  
Email: sales@bushcommantennas.com.au

## SINGLE WIRE ANTENNAS

### **SWC-100**

Single Wire *Centre Fed*  
(2.0MHz-30MHz) 125W  
PEP

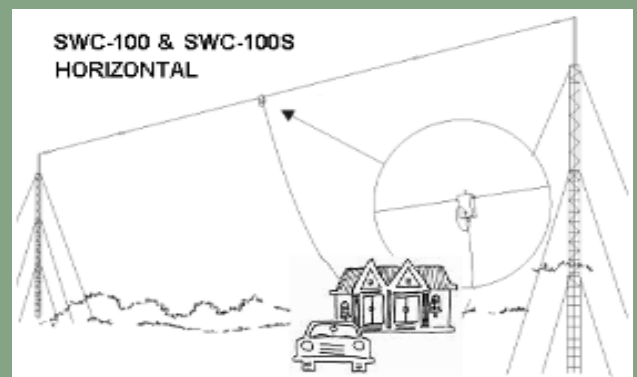
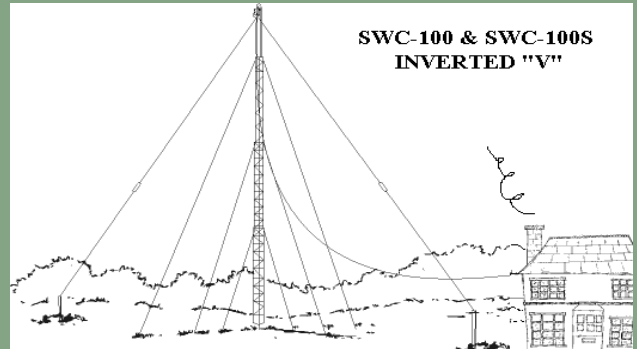

**SWE-100** Single wire *End Fed*  
(3.6-30MHz) 125W PEP. (antenna only)

**SWE-100P**, SWE-100 with **Quick Deployment kit** which includes cable, cord, winder, earth stake and compact rugged carry bag.



Ultraflex stainless steel radiating element

[Back a page](#)

[See next page](#)



## BUSHCOMM MOBILE HF WHIP ANTENNAS

Bushcomm manufactures a range of tapped whip antennas for vehicular use. Models are available in the standard frequency sets of popular Australian HF radio networks. Bushcomm can also produce custom whip antennas for special licenced frequencies on 1.5m and 1.8m masts. Machine wound, and coated in a heavy duty Polyolefin coating, these whips are strong, efficient and affordable. The standard whips are 1800mm high.

Centred frequencies are selected by plugging the selection lead into the correct socket. Full instructions and frequency list are included with all whips.

Tapped whips **require a base** for the coax cable connection **and a mounting spring** to protect the antenna from vibration and collision damage by low objects. The bases have standard UHF SO-239 socket connectors and 1/2" BSW threads.

### Bushcomm 4WD Frequency Sets

**Adventurer 16** RFDS, VKS and VKE (VKE61 absent)



Part #BU00955

*Frequency details on next page*



#### **BASE6**

Heavy Duty Chromed Brass Base . 1/2"BSW, PL259 socket, 55mm high

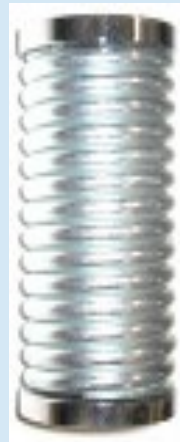

#### **SPR5**

Heavy Duty Zinc plated spring with internal conductor between the end plates. 110mm high.

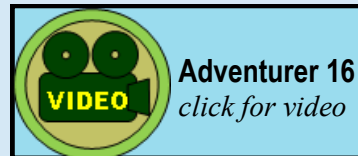

See the [ACCESSORIES](#) Section for other Whip Antenna accessories

[Back a page](#)

[See next page](#)



**Bushcomm**  
2/20 River Road  
Bayswater. WA  
Australia 6053

[Back to index](#)

Phone: +61 8 6144 3204  
Email: [sales@bushcommantennas.com.au](mailto:sales@bushcommantennas.com.au)

## AMATEUR BANDS TAPPED WHIP ANTENNA

### Highlander 8

Bands (m)
10
11
12
15
17
20
30
40
80

### The **Highlander 8**

Vehicle whip is designed for Amateur enthusiasts looking for a dependable amateur bands whip for their vehicle.

Machine wound, and coated in a new heavy duty Polyolefin coating these whips are strong, efficient and affordable.

The **Highlander 8** is designed to cover the amateur bands shown below.

Selecting a band is as simple as plugging in a tap. Fine tuning within a band is performed by adjusting the variable length tip at the top.

**BU00253**



**NEW.** New easy to read labelling is now standard on the Bushcomm Highlander 8 amateur bands tapped whip antenna.

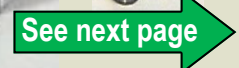
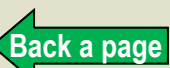



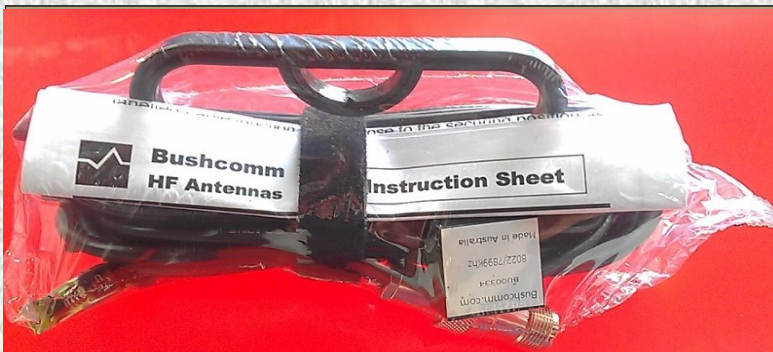

**Bushcomm 7889/8022 KHz Emergency Antenna.**  
This is a small and compact insurance package if you damage your HF antenna or auto tuner in the outback. With a resonant length centred between the most commonly used (VKE237) 7889Khz and (VKS737) 8022KHz frequencies, you will always stay in contact if assistance is required. The length is approx 8 metres, wrapped neatly on a winder with a Velcro keeper for easy storage in your vehicle. Supplied with instruction sheet and female/ female PL259 adapter. # **BU00334**

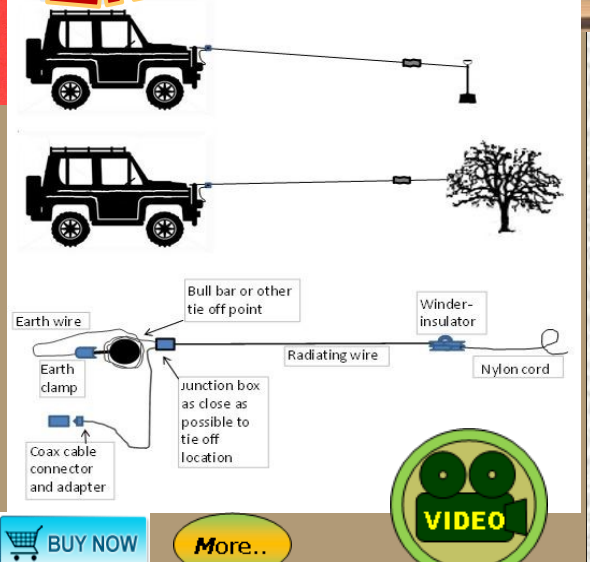

 **BUY NOW**

**More..**



# Marine Survey

*In some instances, Marine Survey radio requirements for yachts and vessels travelling long distances offshore may require HF radio equipment and backup options. The Bushcomm **BU00183M** antenna was approved as a backup antenna for HF tuners*

The **BU00183M** Marine Emergency Long Wire Antenna is a 10m Kevlar cored radiating wire, with a 10m weighted length of cord attached, to ease throwing over a raised feature (e.g. Mast ). The antenna is not tuned and is primarily designed to work in **conjunction** with popular brands of HF antenna tuners. Simply clip the alligator clip to the insulated terminal on the top of your tuner, and away you go. This product is light weight and is perfect as an emergency antenna for "Survey" requirements. Suited to all transceiver power outputs.



 **BUY NOW**

**More..**

 **Back a page**

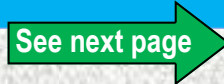
**See next page** 



## Bushcomm HF Marine Backstay Antenna

This marine grade HF antenna is made from 3mm marine grade 316 stainless steel cable, with 316 deck eye plate and turnbuckle. Two sturdy insulators are made from UV resistant Nylon.

A four meter stainless steel tuner connection lead is supplied. It has a Teflon sheath and can be cut to the required installation length. Main radiating element lengths of 13 m or 15 m are available.

Generally these lengths will supply better performance at lower frequencies than than would possible with shorter marine whip antennas. Other Custom lengths are available on request.

### **MARINE BACKSTAYER**

**13 metre** - Part # BU01027

**15 metre** - Part # BU01029

[More..](#)

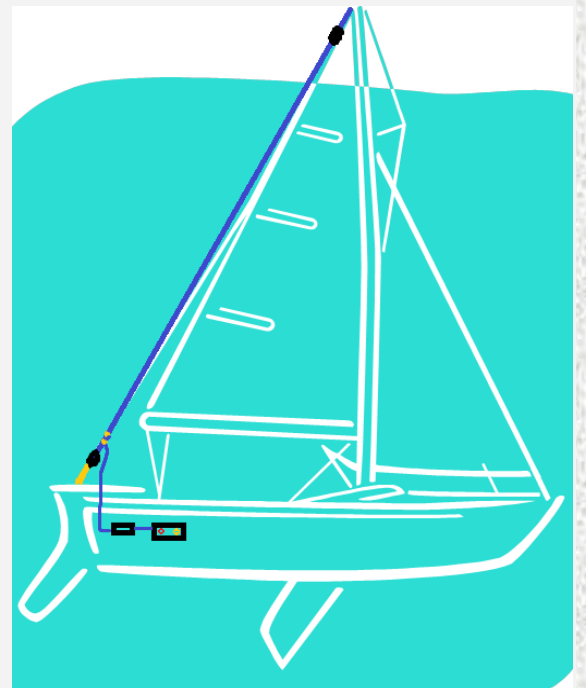
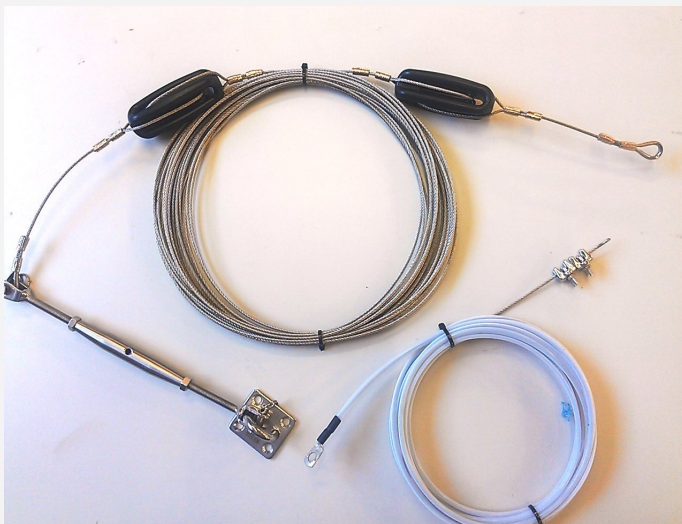

**Bushcomm - supplying HF antenna solutions  
into the world's harshest environments for  
over 30 years..**

[Back a page](#)

[See next page](#)



# HDX-400 Auto Tuning Horizontal Dipole HF Antenna

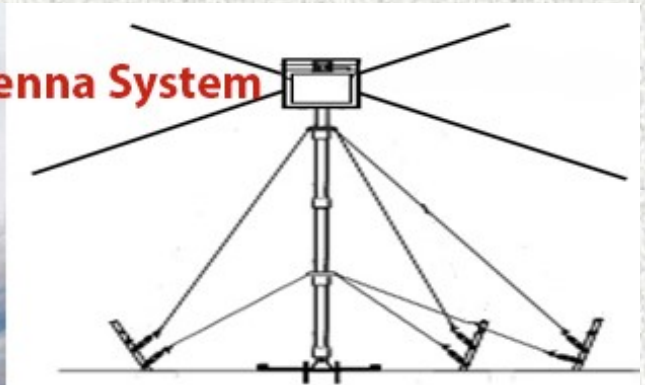

The Bushcomm HDX-400 is a combination horizontal dipole and auto tuner.

The auto tuner is fitted with a pre-amp board for improved reception and Compatibility with ALE enabled Networks.

Perfect for installations with limited space, the HDX has been engineered to suit short distance NVIS and medium range HF communications

### Specs:

**3-30 MHz.**  
**200Watts PEP**  
**VSWR typically less than 1.4:1**  
**Dipole total length 8m**  
**Supplied with clamps for fixing to a 50mm pipe masthead or tower.**  
**Wind rating 150km/hr**  
**Supplied with 20 metres of cabling.**  
**Weight 10kg**

**Bushcomm Antennas Australia**

Drawn aluminium elements are extremely resilient against high winds and bird flocks.

### HDX-400

Self Supported Compact HF Dipole Antenna  
Vertical mast not included. See pages 15-16 for further information on compatible masts

**P/N # BU01214**



"Cats-whisker" design for improved short-medium NVIS Performance.

Transportable 6 metre towers are also available from Bushcomm.

**BU00717**



[Back a page](#)

[See next page](#)

[Back to index](#)



## Vertical Base Station HF Antenna

The VA-85 is made of high grade circular aluminium tubing and is a design that has stood the test of time.

Perfect for applications with limited space for the radiating element.

Accessories available from Bushcomm include a 4:1 balun for compatibility with inline coaxial style tuners.



Bushcomm 4:1 Balun with mounting brackets, shown mounted on a VA-85 (not included)  
Balun # **BAL5**.  
Bracket kit # **BU00351**

**VA-85** Vertical antenna 8.5m





## Horizontal HF Dipole Antenna kit

# Horizon 6.7 HF Antenna

(for use with an Autotuner)

The **Horizon 6.7** antenna kit is a compact self supported dipole antenna specifically designed for "Limited -Small space" applications.

Designed for use with an auto-tuner, each element is fitted with an M5 stud and wing nut to enable easy feed wire connection.

The central bracket has two U bolts to allow fitting to a 50mm OD pipe masthead.

Radiating elements are manufactured from telescoping 25mm & 22mm diameter "**drawn**", not extruded aluminium. This makes them very flexible and extremely resilient to high winds and bird landings.

The width of the assembled antenna is only 6.8 metres. It is configured to operate in a frequency range of 3-54 MHz with the aid of an autotuner. (Subject to the tuning range of your tuner).

The dipole elements are two piece to reduce the shipping length to 202 centimetres. It is easy to assemble and with a weight of **only 3kgs** it is extremely easy to erect.

### Horizon 6.7

# BU01097

- Requires an auto tuner
- Suits 5MHz - 54MHz
- Assembled length 6.8m
- Shipping length 2.02m
- Weight 3kg



Leads showing the manner of attaching feed-wires on the 5mm studs with wing nuts.



Sample of how a balun can be attached using brackets.



Rear view showing the method of attachment to an optional round 50mm vertical masthead.



[Back a page](#)

[See next page](#)



**Bushcomm**  
2/20 River Road  
Bayswater. WA  
Australia 6053

[Back to index](#)

Phone: +61 8 6144 3204  
Email: [sales@bushcommantennas.com.au](mailto:sales@bushcommantennas.com.au)

# Bushcomm Light Weight Towers



**BU00646. 10 metre ground/wire tower**

Product code	Description	<a href="#">More..</a>
<b>BU00717</b>	6m Ground Mounted assembly with <i>rope guys</i> .	<a href="#">BUY NOW</a>
<b>BU00648</b>	10m Roof mounted assembly with s/steel wire guys	<a href="#">BUY NOW</a>
<b>BU00647</b>	10m Ground Mounted assembly with <i>rope guys</i> .	<a href="#">BUY NOW</a>
<b>BU00646</b>	10m Ground Mount Tower with <i>s/steel wire guys</i>	<a href="#">BUY NOW</a>
<b>TOW4</b>	12m Tower with s/steel wire guys	<a href="#">BUY NOW</a>

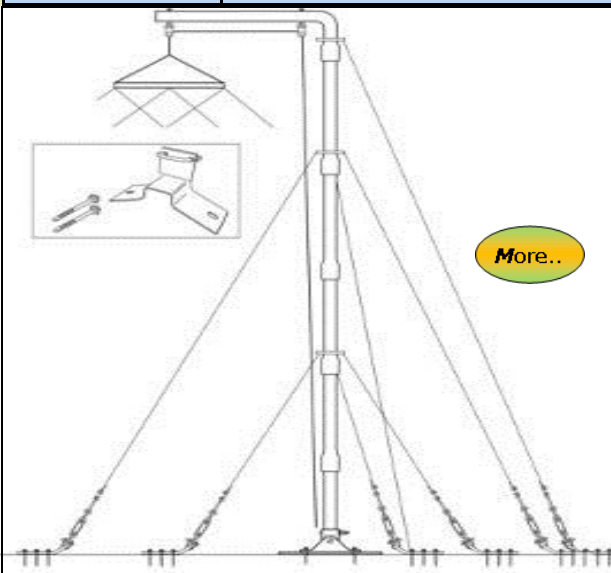

**BU00648** - 10m tower with **roof** mounting kit, s/steel guys.. Ensure all safety measures and equipment are in place during erection.

[Back a page](#)

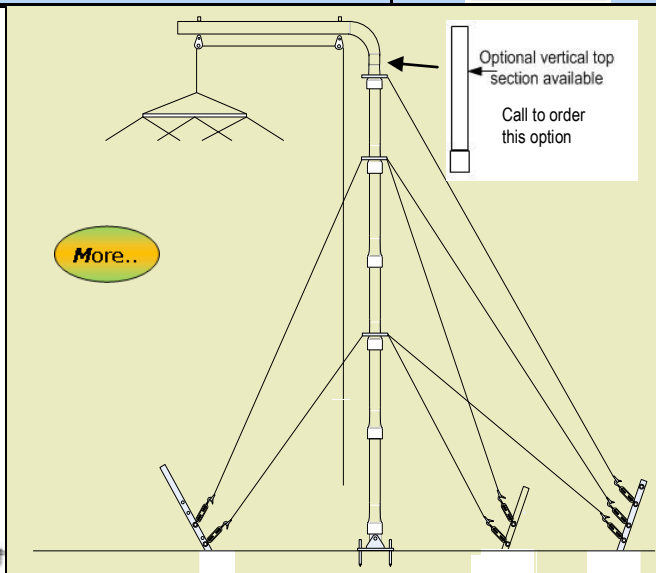

**BU00646, BU00647** - 10m **ground** mount towers. Manual installation.

[See next page](#)



## Bushcomm Light Weight Towers



**MIL-51** BU00012  
**Portable Elevation Kit**  
**5m Tower**

The Portable Elevation Kit rolls up and packs away quickly for easy storage and transport  
Most suitable for single wire quick deployment antennas.  
Only 5.5kg



[More..](#)

[BUY NOW](#)

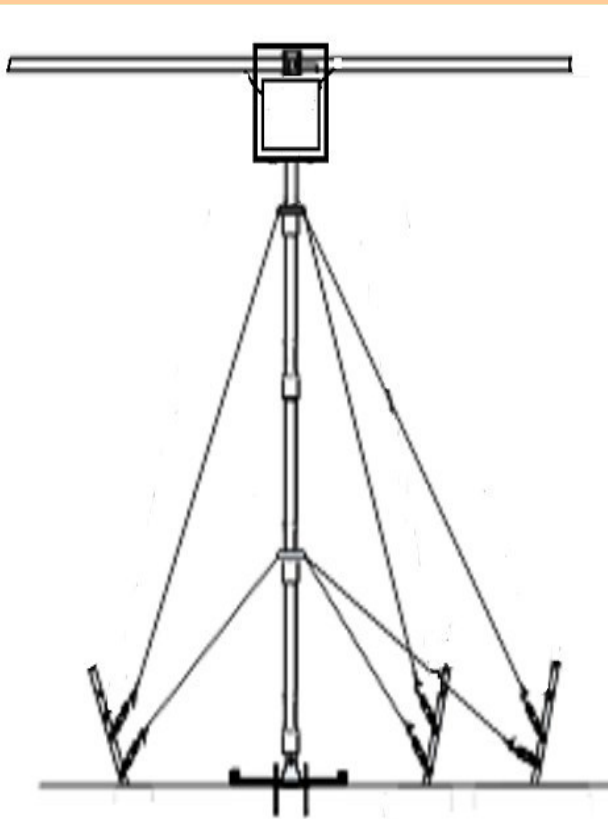

*Left:* Bushcomm also has  
**6 metre towers** available. #BU00717 .

These are made of light weight round 50mm diameter aluminium tubing and use 6mm polyester guy ropes.  
Multi purpose. They are fitted with a vertical 450mm stub Ideal for HDX-200, HDX-6K and HDX-8K kits. Pictured *left* with Auto tune Horizontal Dipole HDX-200 #BU00933.

[More..](#)

[BUY NOW](#)

[Back a page](#)

[See next page](#)

## Counterpoise Products



**Bushcomm single wire counterpoise** package designed for portable radio systems. Made with Kevlar cored PVC coated copper braid cable . Standard termination is with a flat blade terminal. Custom termination is available to suit your transceiver. Please call

The 10 metre element is terminated with a 200mm long stainless steel earth stake.

**BU00197**



**Four Wire Radial Kit.** Bring out the best in your vertical or beam antenna.



Custom model shown, incorporates 5mm 304 stainless steel wire, Stainless steel ferrules and a 4 metre perimeter radiating hub.

The **Bushcomm Multiwire Counterpoise System** is designed to work with single element vertical antennas that require a good counterpoise / ground plane system. It provides improved performance for ground dependant antennas in conditions of low ground conductivity. Eight 10 metre 3.2mm 304 grade stainless steel elements radiate from a central two metre circumference hub, fastened together with copper ferrules.

Two, 2 metre leads with M8 eye terminals provide the connection point to autotuners etc. Loops at the end of each element provide secure anchoring points., if required.

Ideal for both ground and high rise roof top installations. **#BU01005**

**Custom variations can be modelled for your requirements.**



[Back a page](#)

[See next page](#)

[Back to index](#)



# Parts And Accessories

## Ready Made Coax Cables



Bushcomm coaxial cables feature quality sealed Clamp style connectors.

Code	Description	Length	Male Connectors	Connector finish
CX2	RG58 Coaxial	5m	BNC/UHF	bright
CX4	RG58 Coaxial	5m	UHF	bright
CX8	RG213 Coaxial	30m	UHF	bright
BU00010	RG58 Coaxial	10m	UHF	bright
BU00415	RG58 Coaxial	30m	UHF	black
BU00416	RG58 Coaxial	10m	UHF	black
BU00422	RG58 Coaxial	10m	BNC/UHF	black
BU00542	RG213 Coaxial	30m	UHF-N	bright
BU00661	RG58 Coaxial	1m	UHF	bright
BU00662	RG58 Coaxial	0.5m	UHF	bright
BU00757	RG258 Coaxial	10m	N-BNC	black
BU00829	RG58 coaxial	20m	N-N	black
BU00879	RG58 coaxial	20m	UHF	black

[Back a page](#)

[More..](#)



[Buy accessories here](#)

[See next page](#)

# Antenna Accessories

## SPR5

Heavy Duty  
Zinc plated spring.  
Braid connection  
between top and  
bottom plates



 [BUY NOW](#)

## BASE6

Heavy Duty Chromed Brass Base to  
suit antenna mounting spring.. 1/2"  
BSW threads



 [BUY NOW](#)

## BU00156

Combined Heavy Duty  
Spring and Base.  
1/2"BSW threads.



 [BUY NOW](#)

## FLT1

Noise Filter

Eliminates electrical noise in vehicles from sources like alternators, wipers etc. 50 amp continuous, 50 V max. Designed to be wired in line to the vehicle alternator or transceiver power source.

**NB:** this product is best suited to older basic vehicles and marine installations. Modern vehicle alternators generally output more than the 50A filter rating. Other modern noise sources such as electronic injectors create RF interference that this filter is not designed to eliminate.

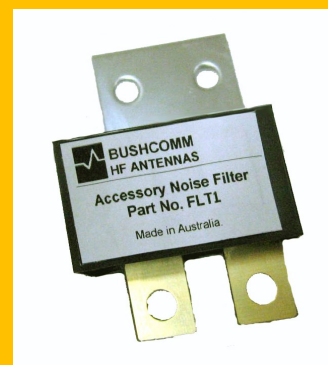

 [BUY NOW](#)

 [Back a page](#)

[See next page](#) 



### Surge (lightning) Arrestor

**BSA-150** 150 watt  
**BSA-1000** 1000 watt



[More..](#)

[BUY NOW](#)

### PTS

Pig Tail strain relief for Bushcomm Multiwire & single wire antennas, to suit larger (RG213) cable. Attach to stud on rear of Balun and wind cable through pigs tail.



[BUY NOW](#)

### BAL5

4:1 Balun to suit VA71 & minibeam antennas. (Includes Bracket set)

Allows Coax feed connection from tuner to base of the antenna.

PL259 connector and M5 threaded terminals.



[BUY NOW](#)

### STBK

Stand off Bracket to suit all long wire antennas. Designed for inverted "V" configuration, mounted to 50mm pipe mast. 1250mm arm with hoisting pulleys.



[BUY NOW](#)

### Stainless Steel Whips. Barrett Communications

#### BU00894

Stainless Steel Whip top to suit Barrett Auto tuner. Heavy duty 2 metre whip with thread to suit Barrett 2019 or 4049.

[BUY NOW](#)

#### BU01662

Stainless Steel Heavy Duty Whip top to suit Barrett Auto tuner. 2.65M

[BUY NOW](#)

### Codan

#### WHC-1 / BU01451 / BU01487

Stainless Steel Whip top to suit Codan 9350 & 3040 Autotuner.

Heavy duty 1.6, 2.0 or 2.6 Metre

[BUY NOW](#)



[Back a page](#)

[See next page](#)

## Bushcomm Quality for Amateur Radio Enthusiasts

Available at:  
[www.bushcomm.com](http://www.bushcomm.com)



**BA-40** 20m long resonant dipole (total length).

[More..](#)



**BA-40B** As above , with 1:1 Balun included

[More..](#)



**BA-80** 40m long resonant dipole (total length).

[More..](#)



**BA-80B** As above , with 1:1 Balun included

[More..](#)



### Longwire Broadband Antenna

Requires an autotuner.

This 20m 316 stainless steel antenna will suit most autotuners. It has a 4m input lead.

[More..](#)

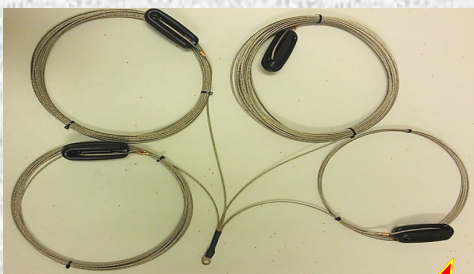

### Four wire radial kit.

This will bring out the best in your beam or vertical antenna. The stainless steel radials have insulated ends for suspending above ground or staking at ground level. 20m, 10m, 5m, and 2.5m radials.

[More..](#)



**Contact Us  
Here**

This is only a small selection of what amateur related products we have available. Email or call us for all of you HF antenna requirements





### Who is Bushcomm?

Bushcomm specialises in the manufacture of high frequency (HF) antennas. We have a wide selection of antennas, ranging from multi-wire and single-wire base station antennas to portable antenna and mobile models.

Established in South Australia in 1990 and now headquartered in Perth, Western Australia, we have built up a global client base through products known for quality and reliability in the world's harshest environments.

In recent years specialised VHF products have been added to our product list.

Our products are highly effective, and made from the best quality components. They have proven to be durable in all types of extreme conditions: from cyclonic tropical areas in Papua New Guinea, to the deserts of central Australia, to the sub-zero temperatures of the Antarctic.

Bushcomm addresses all sectors where basic communication infrastructure is not available: military, mining, government, humanitarian aid, rescue, forestry and police and emergency services. We also supply professional communications organisations, outback travellers and HF amateurs.

In the tactical HF market, our portable antennas meet all critical requirements from quick deployment, to reliable uncompromising performance.



Bushcomm CNC tapped whip lathe. Bushcomm is one of the only tapped whip manufacturers left worldwide. See the [Video](#)

### Adaptive and Innovative

Although HF is considered a mature technology, we at Bushcomm constantly strive to improve our products and processes to increase the quality on which the company was built. Bushcomm has a strong commitment to research and developing new products and improvements for the radio communications market. Our products are always being reviewed and refined; our company is constantly evolving. With new production processes, we are able to accommodate custom orders and special requirements.

### Our Guarantee

Every Bushcomm product is made with care from quality materials to ensure the highest possible quality end product. With exhaustive testing at every stage, you can be assured of a long lasting reliable product. We stand by our products and we will do our utmost to ensure customer satisfaction.

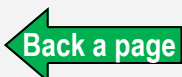

[Back to index](#)